

SMA Series *-SMA Connectors*

Panel Mount Solder Pot PIN Jack (2 Holes)

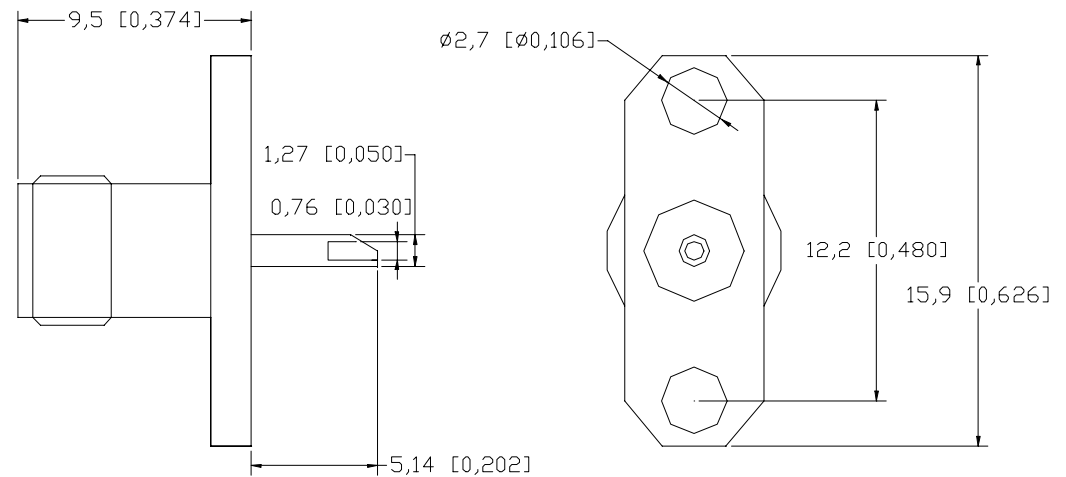

PAF-S00-003



Unit : mm[inch]



Excellence and Innovation in RF & Microwave Components